



# LCD Module Technical Specification

T-51381L064J-FW-P-AD

Checked by (Quality Assurance Div.)

Checked by (Design Engineering Div.)

Prepared by (Production Div.)

## Table of Contents

1. Application .....	2
2. Features .....	2
3. Mechanical Specifications .....	2
4. Mechanical Drawing of module.....	3
5. Input/output Terminals .....	4
6. Absolute Maximum Ratings.....	5
7. Electrical Characteristics .....	5
8. Optical Characteristics .....	15
9. Handling Cautions .....	18
10. Reliability Test.....	19
11. Block Diagram.....	20

## Revision History

Rev.	Date	Page	Comment

## 1. Application

This technical specification applies to 6.4" color TFT-LCD module, T-51381L064J-FW-P-AD.

## 2. Features

- . Compatible with NTSC and PAL system
- . Pixel in stripe configuration
- . Slim and compact
- . Active area / Outline area = 67.9 %
- . Aperture Ratio : 60 %
- . Optimum Viewing Direction : 6 o'clock

## 3. Mechanical Specifications

Parameter	Specifications	Unit
Screen Size	6.4 (diagonal)	inch
Display Format	960×234	dot
Active Area	130.6 (H)×97.3 (V)	mm
Dot Pitch	0.136 (H)×0.416 (V)	mm
Pixel Configuration	Stripe	
Outline Dimension	156.3 (W)×119.8 (H)×19.2 (D)	mm
Weight	320±5	g

# 4. Mechanical Drawing of TFT-LCD Module

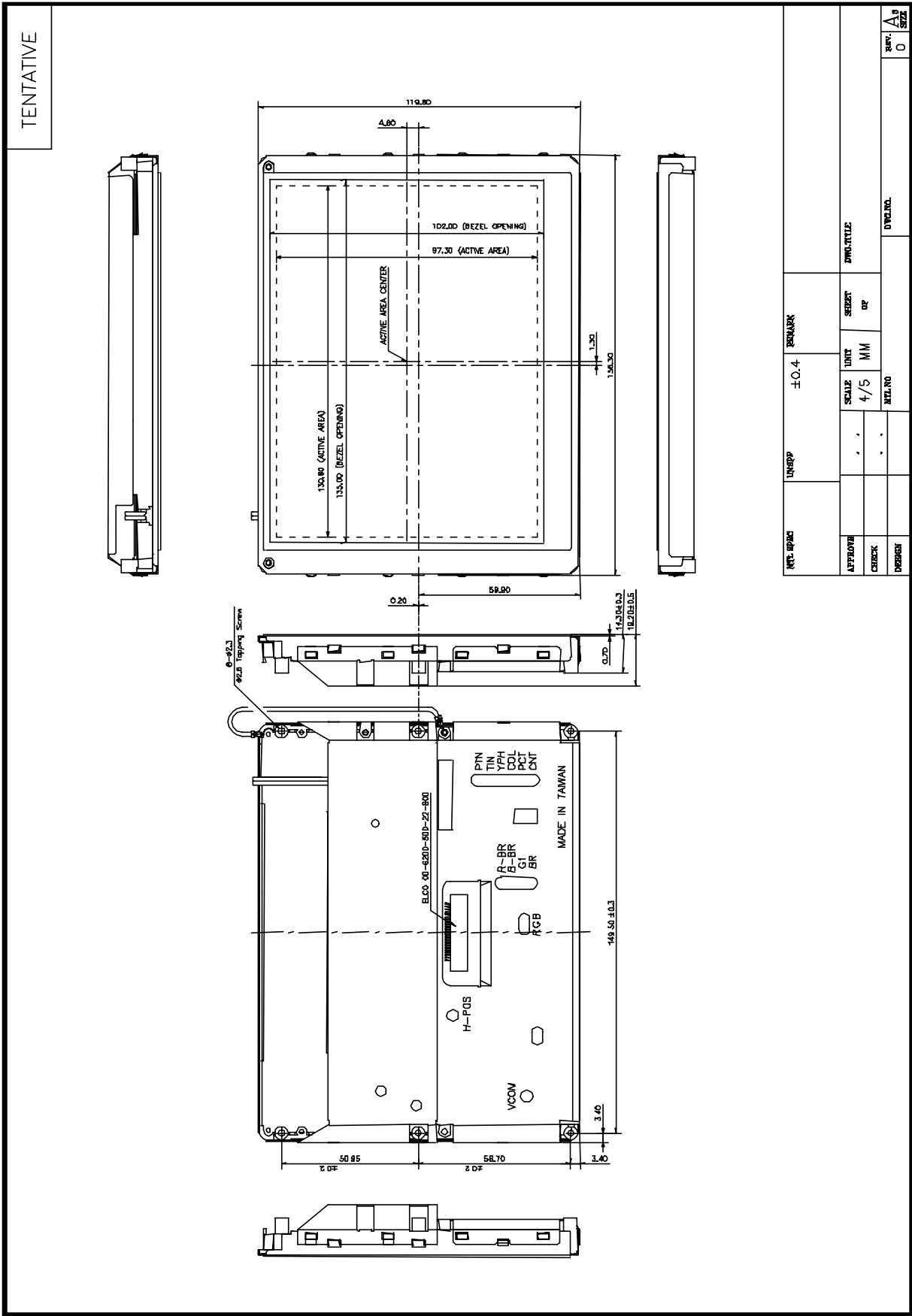

REV. 0	SIZE	DRAWING NO.	
0	A		
DESIGNER	CHECK	APPROVE	DATE
SCALE	UNIT	REVISION	DESCRIPTION
4/5	MM		
±0.4	OR		
UNREP	REMARK		

## 5. Input / Output Terminals

### 5-1) TFT-LCD Panel Driving

#### A) Connector (22 Pins)

Pin No	Symbol	I/O	Description	Remark
1	+12V	O	High Level for Module	
2	+12V	I	High Level for Module	
3	12VGND1	I	Ground for +12V	
4	12VGND2	I	Ground for +12V	
5	30V	O	Supply Voltage for Customers	Note 5-5
6	20V	O	Supply Voltage for Customers	Note 5-5
7	V <sub>DD</sub>	O	Supply Voltage for Logic Circuit	Note 5-4
8	ENB	I	Switching Power Enable	
9	GND	I	Ground	
10	VIN	I	Composite Video Signal Input	Note 5-1
11	CNT	I	Contrast Control Pin	Note 5-1
12	BRI	I	Brightness Control Pin	Note 5-1
13	COL	I	Color Control Pin	Note 5-1
14	TINT	I	Correct the Output Amplitude of Color in PAL Mode	
15	$\overline{\text{HSY}}$	O	Horizontal Sync. Output	
16	$\overline{\text{VSY}}$	O	Vertical Sync. Output	
17	R	I	Digital R(Red)	
18	G	I	Digital G(Green)	
19	NP	I	NTSC Select Pin	Note 5-2
20	SW	I	Composite or RGB Selection Pin	
21	DIM	I	Backlight Brightness Control Pin	
22	RL	I	Right/Left Select Pin	Note 5-3

Note 5-1: The range of parameter adjustment:

Pin No	Symbol	Min.	Typ.	Max.	Unit
10	VIN	3.15	2.3	1.6	V
11	CNT	1.85	2.29	2.68	V
12	BRI	0.34	1.46	2.37	V
13	COL	1.67	1.81	2.1	V

Note 5-2: High (+5V) is NTSC system. Normal condition is high.

Note 5-3: High (+5V) is normal, Low (0V) is Right/Left reverse and Open is normal.

Note 5-4: V<sub>DD</sub> can supply 160mA output current.

Note 5-5: 30V, 20V can supply 5mA output current.

5-2) Backlight driving

Pin No	Symbol	Description	Remark
1	VL1	Input terminal (Hi voltage side)	
2	VL2	Input terminal (Low voltage side)	Note 5-6

Note 5-6 : Low voltage side of backlight inverter connects with Ground of inverter circuits.

5-3) Input / Output Connector

- A) Video & Power Input Connector
- ELCO 00-6200-500-22-800
- UP Connector
- Pin No. : 22
- Pitch : 1.0 mm

6. Absolute Maximum Ratings:

GND = 0 V , Ta = 25 C

Parameter	Symbol	MIN.	MAX.	Unit	Remark
Supply Voltage for Source Driver	V <sub>SH</sub>	-0.5	+16	V	
Supply Voltage for Gate Driver	H Level	V <sub>GH</sub>	-0.3	+26.5	V
	L Level	V <sub>GL</sub>	-7	20	V
Supply Voltage for controller	V <sub>DD</sub>	-0.3	+6.5	V	
Digital Input Signals		-0.5	+5.5	V	
Digital Output Signals		-0.5	+5.5	V	
Storage Temperature		-30	+80	°C	
Operation Temperature		-10	+60	°C	

7. Electrical Characteristics

7-1) Recommended Operating Conditions:

- A) Driving for TFT-LCD Panel

GND = 0V , Ta = 25 C

Parameter	Symbol	MIN.	TYP	MAX.	Unit	Remark	
Supply Voltage for Module	+12V	+10	+12	+14	V		
Supply Voltage for Source Driver	V <sub>SH</sub>	+13.5	+14	+14.5	V		
Supply Voltage for Gate Driver	H Level	V <sub>GH</sub>	+19.5	+20	+20.5	V	
	L level	V <sub>GL</sub>	-5.5	-5	-4.5	V	
Supply Voltage for Controller	V <sub>DD</sub>	+4.7	+5	+5.3	V		
Output Voltage +30V	+30V	30	-	34	V		
30V Output Voltage Current	I <sub>30V</sub>	-	-	15	mA		
Digital Input Voltage	H level		+2.4	-	+5	V	Note 7-1
	L level		-0.3	-	+0.8	V	
Digital Output Voltage	H level		+5	+5.5	V	Note 7-2	
	L level		0	-	+0.45		V

Note 7-1 :  $\overline{HSY}$  ,  $\overline{CSY}$  ,  $\overline{VSY}$  ,

Note 7-2 :  $\overline{HSY}$  ,  $\overline{VSY}$  ,

B) Power on sequence (Voltage source)

The power on sequence only effect by  $V_{DD}$ ,  $V_{GL}$  and  $V_{GH}$ , the others do not care.

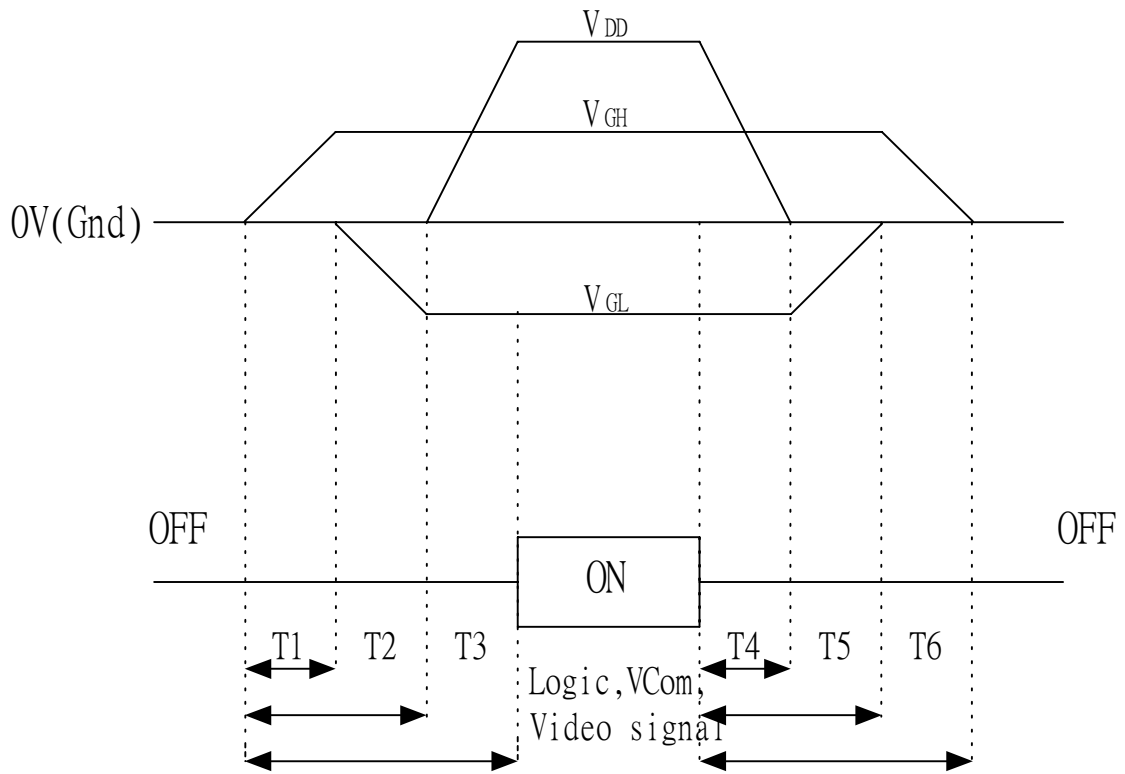

- 1) 10ms T1 T2 T3
- 2) 10ms T4 T5 T6

C) Driving for backlight

$T_a = 25\text{ C}$

Parameter	Symbol	Min.	Typ.	Max.	Unit	Remark
Lamp voltage	$V_L$	480	520	560	Vrms	$I_L = 6\text{mA}$
Lamp current	$I_L$	4	6	8	mA	
Lamp frequency	$P_L$	20		60	KHz	Note 7-3
Kick-off voltage	$V_s$			1500	Vrms	

Note 7-3 : The wave form of lamp driving voltage should be as closed to a perfect sine wave as possible.

## 7-2) Power Consumption

Ta= 25 C

Parameter	Symbol	Conditions	TYP.	Unit	Remark
Supply Current for LCD Module	+12V	V=+12V	720	mA	Note 7-4
LCD Module Power Consumption			8.64	W	

Note 7-4 : It includes the loading of the system.

## 7-3) Input / Output signal timing chart

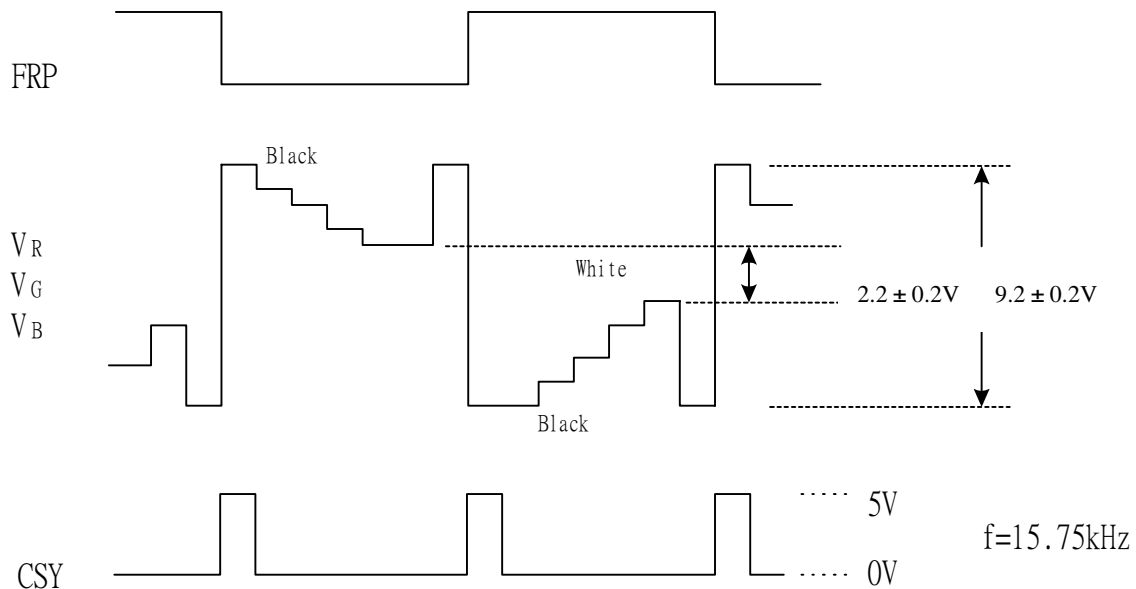

Parameter	Symbol	MIN.	TYP.	MAX.	Unit	Remarks
Horizontal Sync. Output Pulse	Width	$T_{HO}$	4.2	4.7	5.2	$\mu s$
	Phase Difference	$T_{HP}$	0	2		$\mu s$
	Rising Time	$T_{HR}$	-	-	0.5	$\mu s$
	Falling Time	$T_{HF}$	-	-	0.5	$\mu s$
Vertical Sync. Output Pulse	Width	$T_{VO}$	-	4H	-	$\mu s$ H=1/15.75KHZ
	Phase Difference	$T_{VPO}$	-	1H	-	$\mu s$ odd field
	Phase Difference	$T_{VPE}$	-	0.5H	-	$\mu s$ even field
	Rising Time	$T_{VR}$	-	-	2	$\mu s$
	Frequency	$f_{FRP}$	7.67	7.87	8.07	KHz
Polarity Alternating Signal	Delay time	$T_{FD}$	-	-	4	$\mu s$
	Falling Time	$T_{VF}$	-	-	2	$\mu s$

### 7-4) Display Time Range

A) When sync. signal of NTSC system is applied.

- a) Horizontally  
12.6 ~ 63.39  $\mu$  s.
- b) Vertical  
19 ~ 253 H

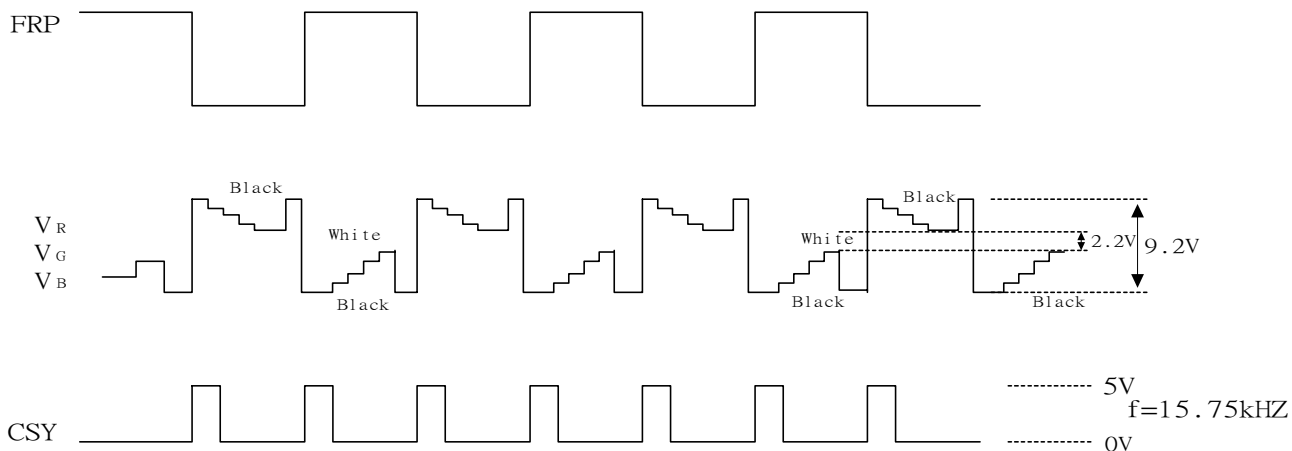

B) When sync. signal of PAL system is applied.

- a) Horizontally  
13.0 ~ 63.8  $\mu$  s.
- b) Vertical  
26 ~ 298 H
- c) odd field : Scan lines  $14n+17$   $14n+23(n=1,2,3\dots)$  are not displayed.  
even field : Scan lines  $14n+12$   $14n+20(n=1,2,3\dots)$  are not displayed.

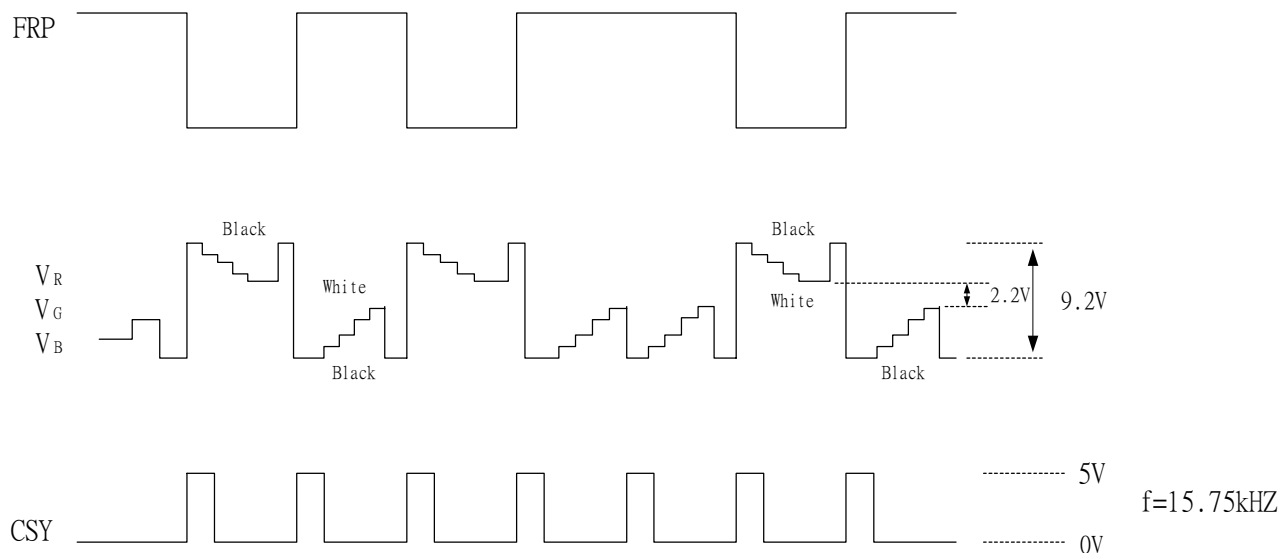



### C) NTSC Timing Diagram

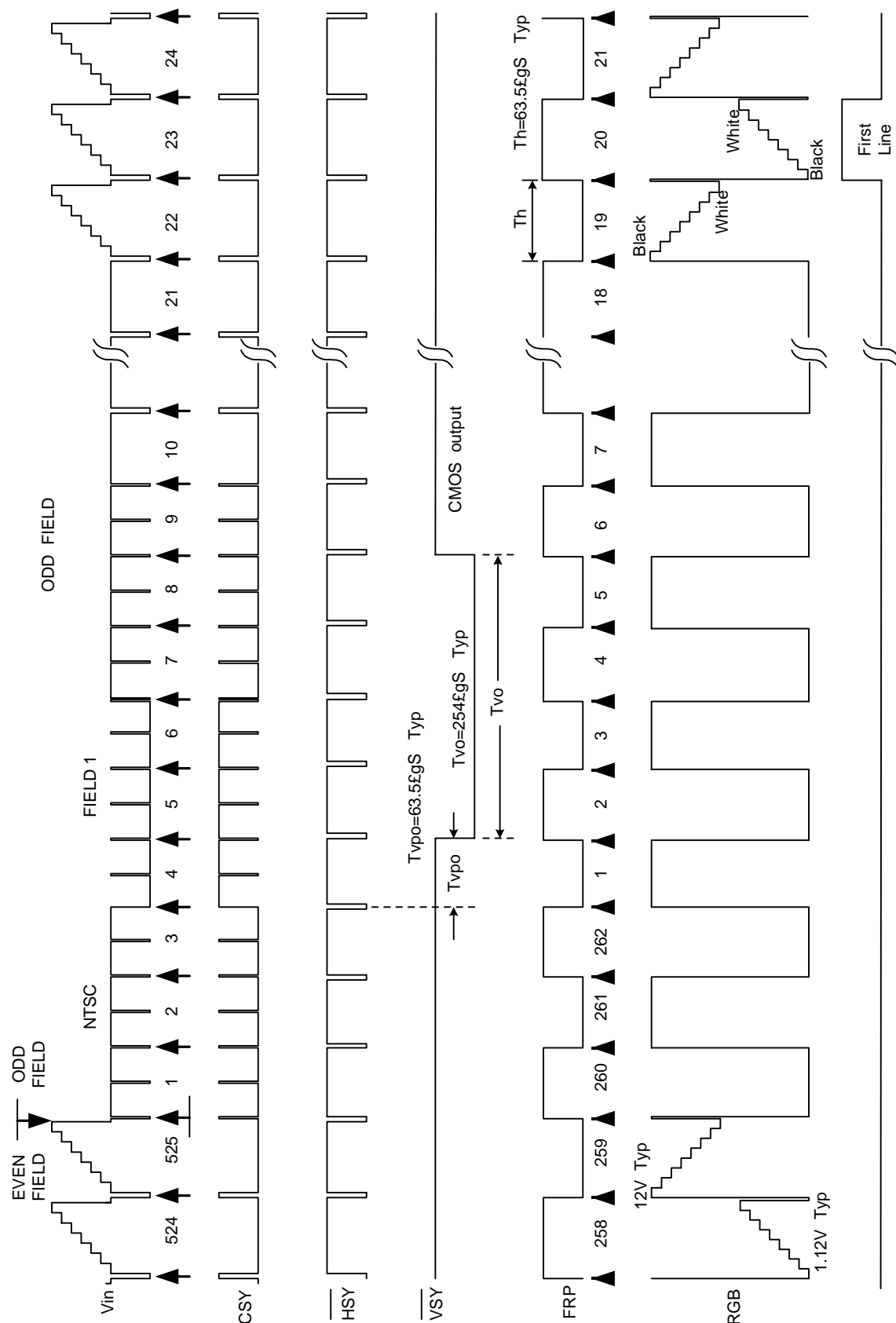

Timing chart of I/O and RGB signal

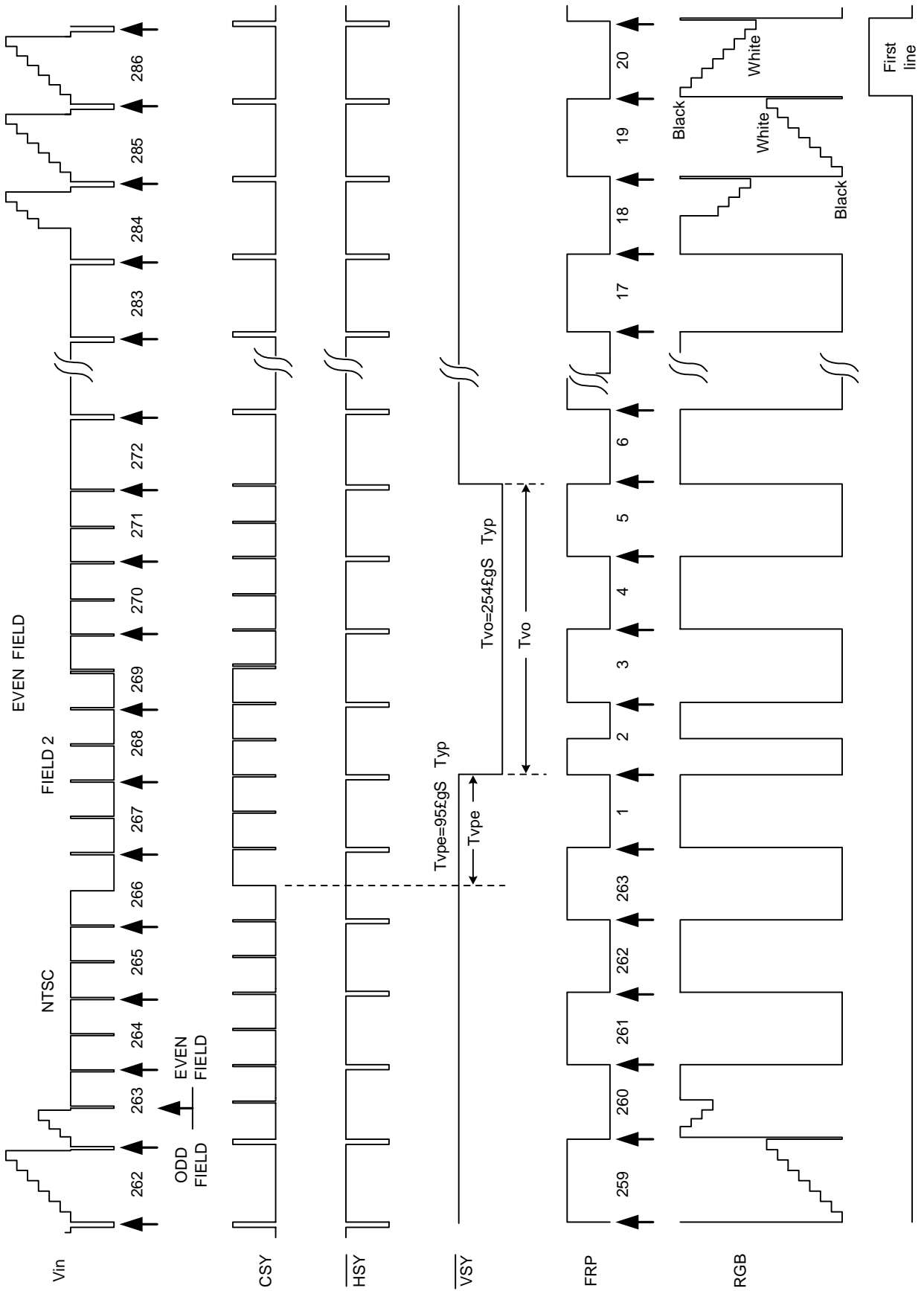

Timing chart of I/O and RGB signal

# NTSC Display Timing

Sampling Clock: 18.9MHz

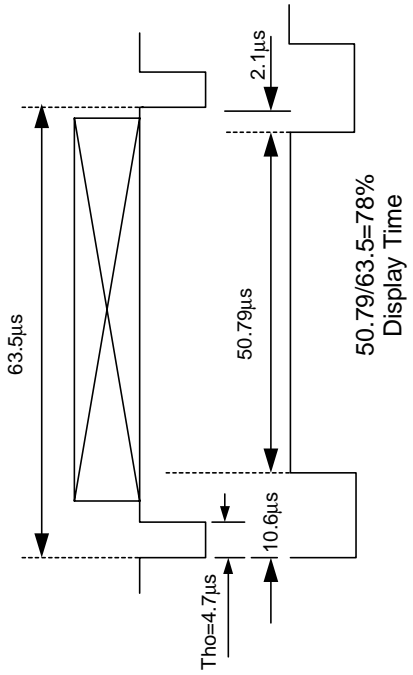

(1) Horizontal Timing

(2) Vertical Timing

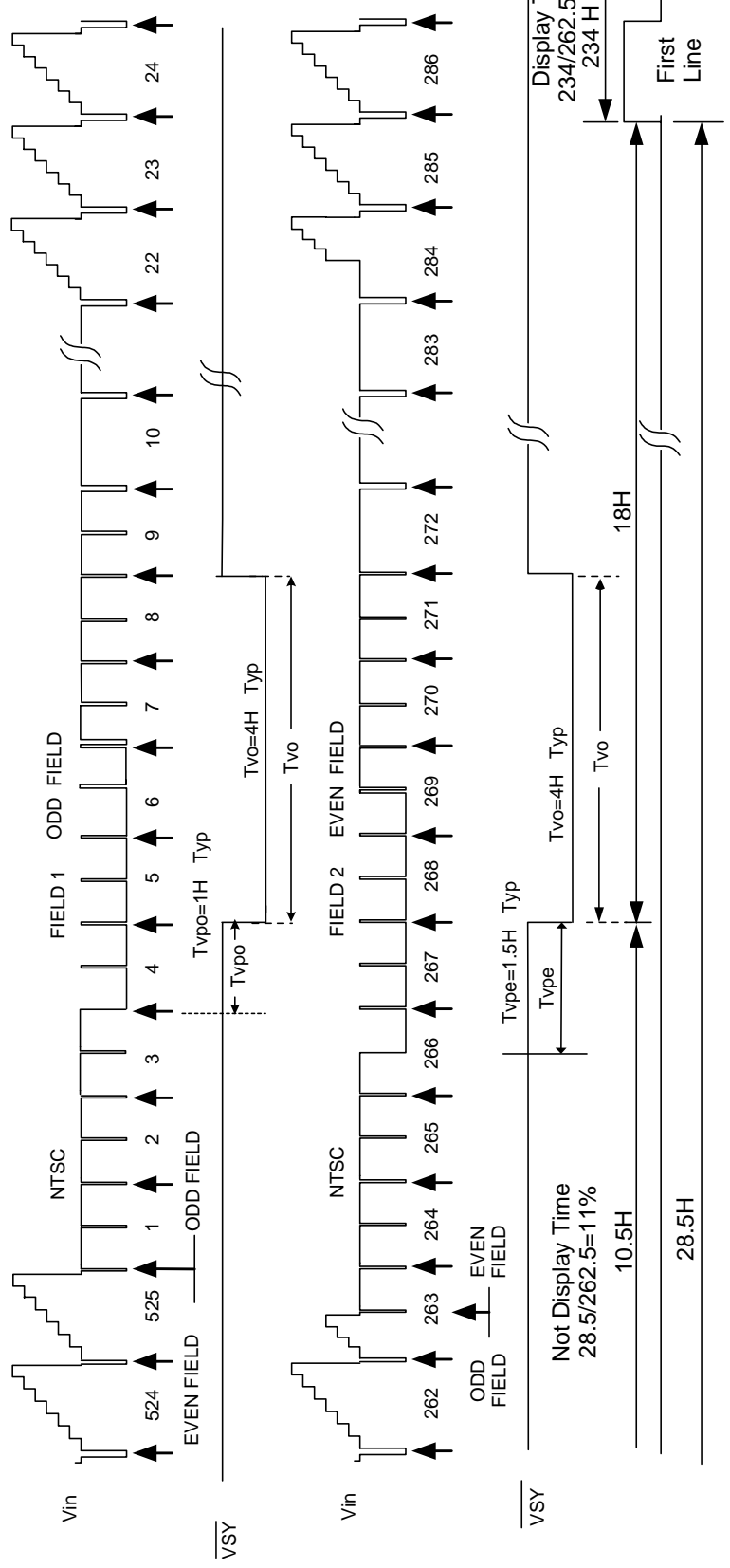

### C) PAL System

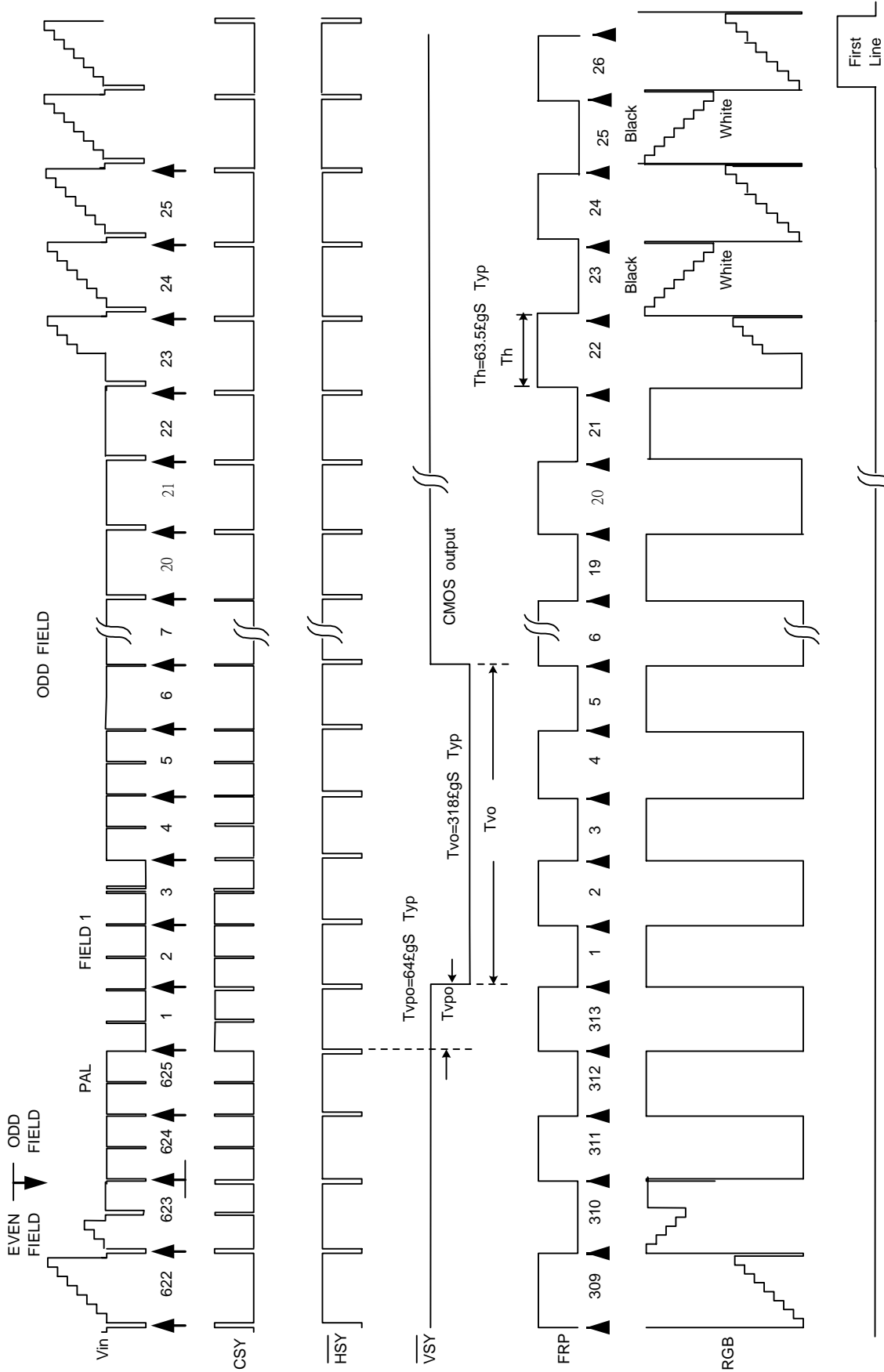

Timing chart of I/O and RGB signal

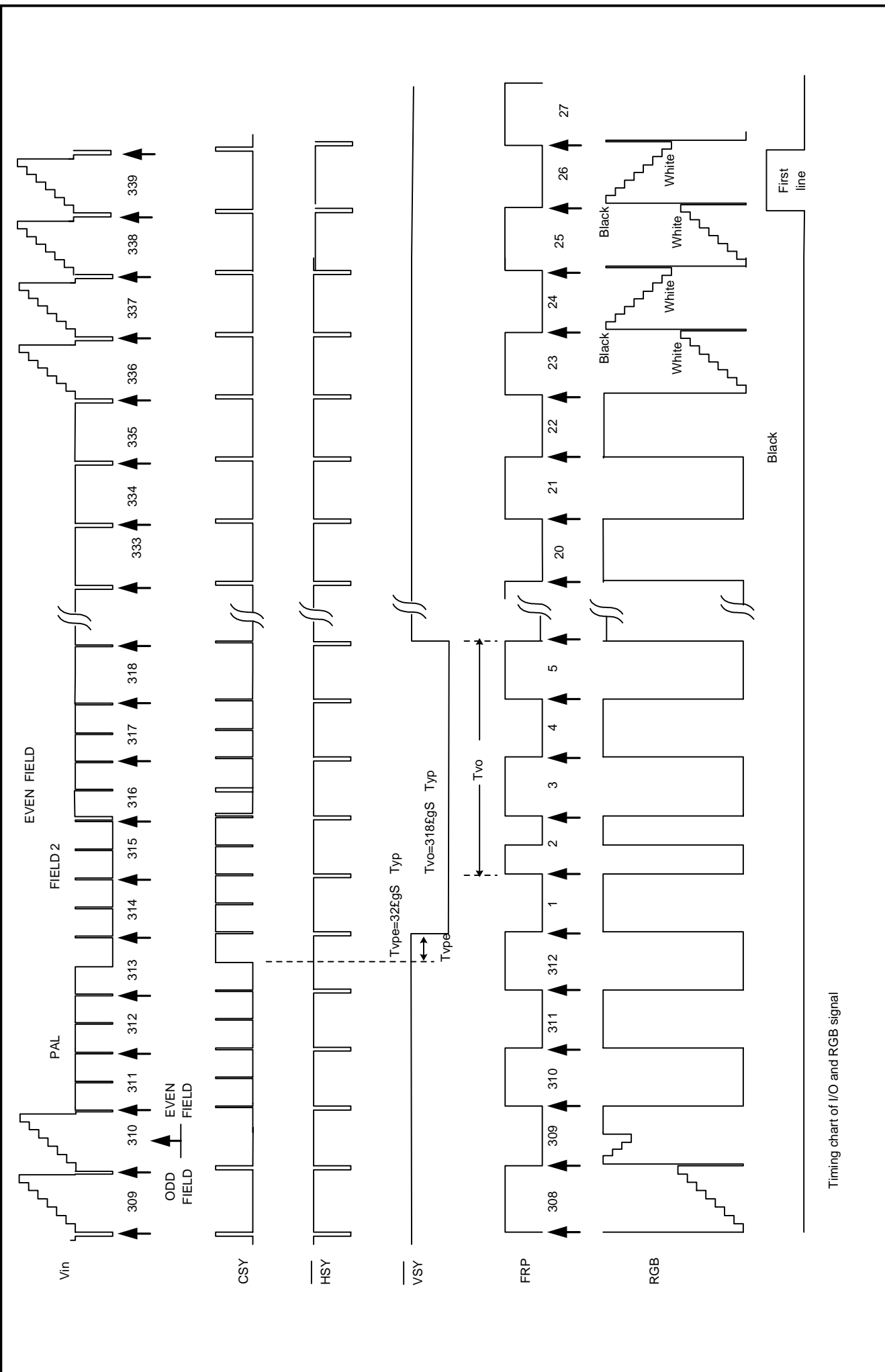

Timing chart of I/O and RGB signal

Sampling Clock: 18.9MHz

(1) Horizontal Timing

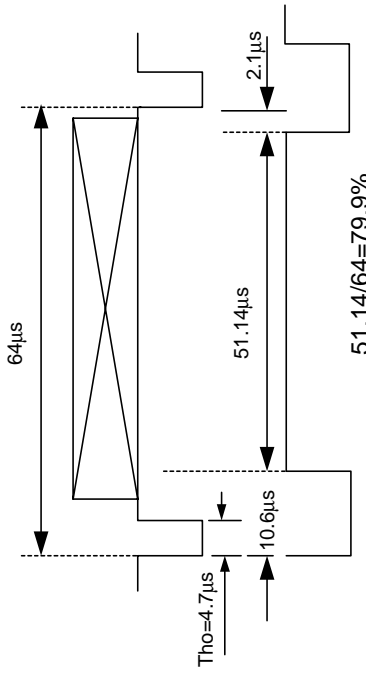

(2) Vertical Timing

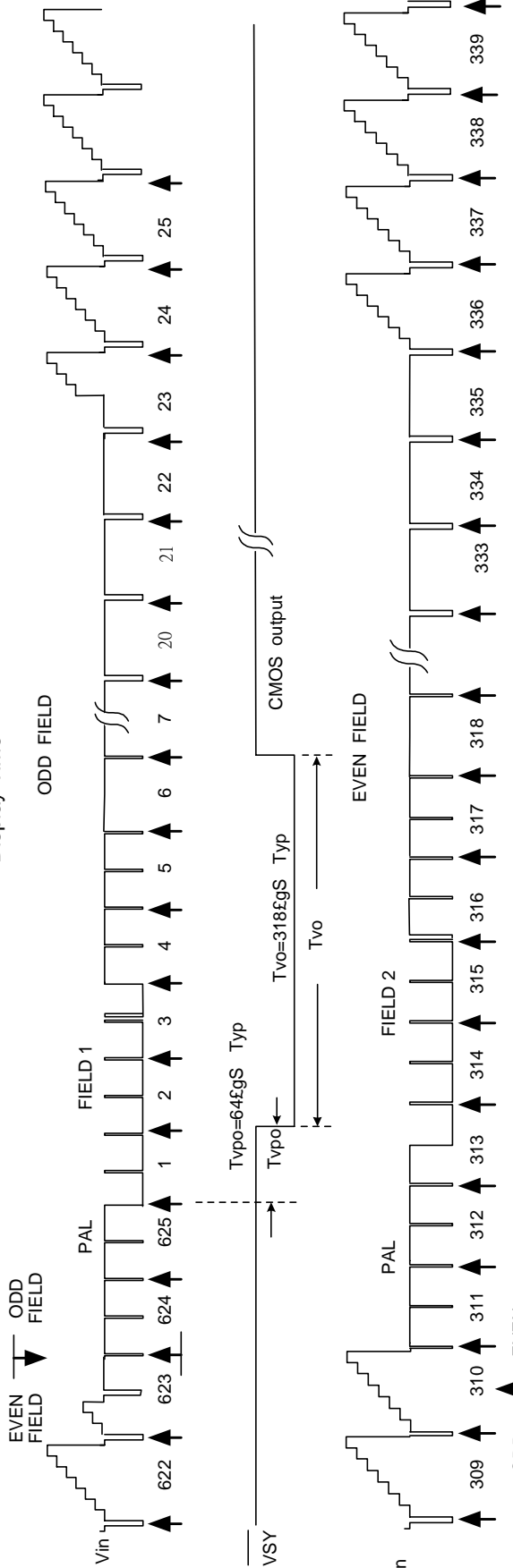
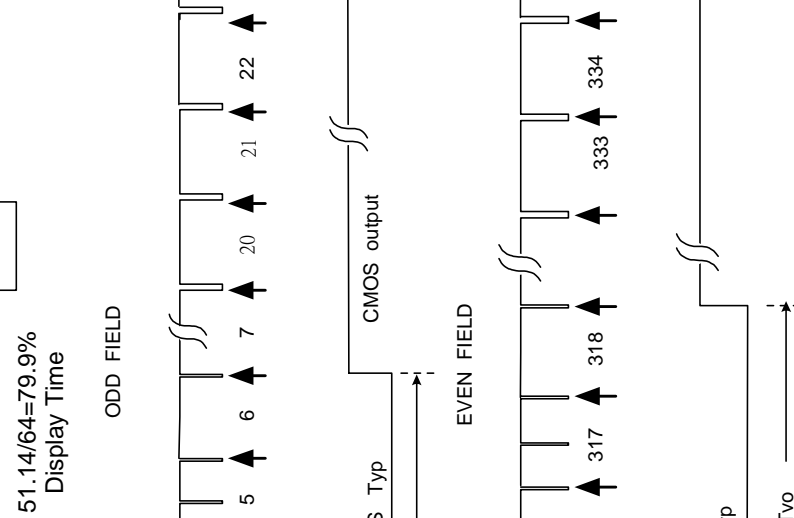

Not Display Time  
28.5/310=11%

Display Time  
234/310=75.5%

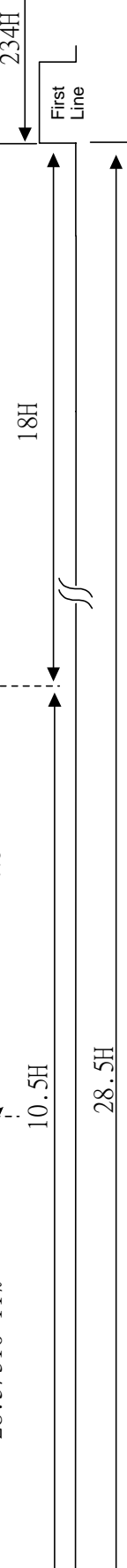

## 8. Optical Characteristics

### 8-1) Specification:

Ta = 25°C

Parameter	Symbol	Condition	MIN.	TYP.	MAX.	Unit	Remarks
Viewing Angle	Horizontal	$\theta$	$\pm 45$	$\pm 55$		deg	Note 8-1
	Vertical	$\theta$ (to 12 o'clock)	10	15		deg	
		$\theta$ (to 6 o'clock)	30	35		deg	
Contrast Ratio	CR		80	120			Note 8-2
Response time	Rise	Tr			30	ms	Note 8-4
	Fall	Tf			50	ms	
Reflectance Ratio	R			6.0		%	
Brightness			250	300		cd/m <sup>2</sup>	Note 8-3
White Chromaticity	x		0.255	0.305	0.355		
	y		0.300	0.350	0.400		
Lamp Life Time	+25°C		10,000			hr	

Note 8-1: The definitions of viewing angles

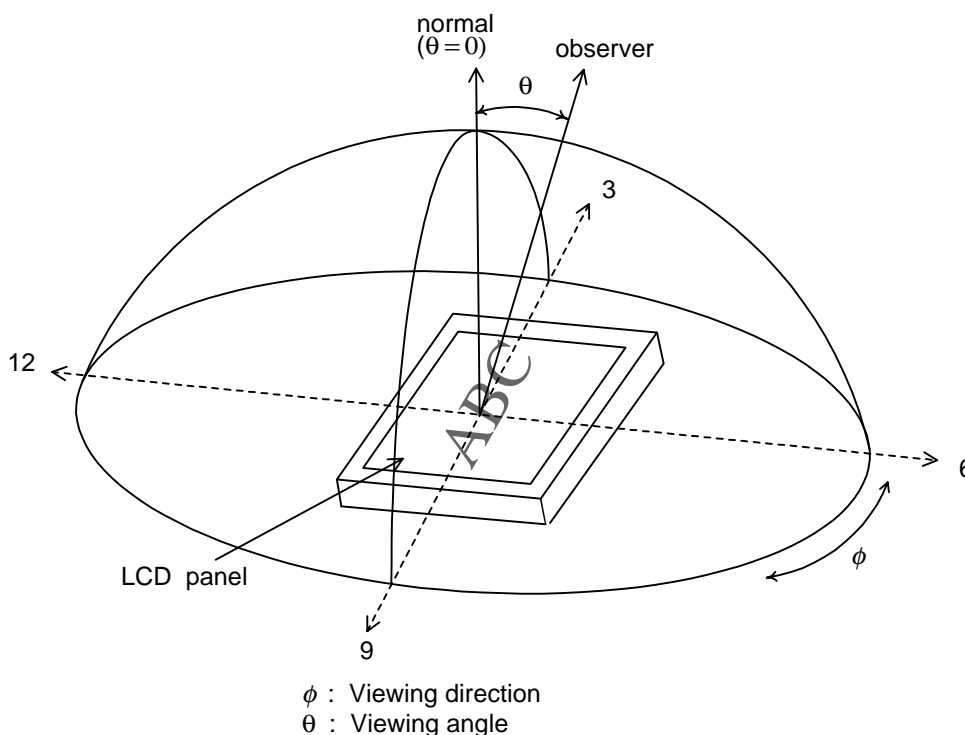

Note 8-2 : CR =  $\frac{\text{Luminance when Testing point is White}}{\text{Luminance when Testing point is Black}}$

(Testing configuration see 8-2)

Contrast Ratio is measured in optimum common electrode voltage.

Note 8-3 : Topcon BM-7(fast) luminance meter 2° field of view is used in the testing (after 20~30 minutes operation).

Lamp Current is 6mA.

Note 8-4 : The definition of response time:

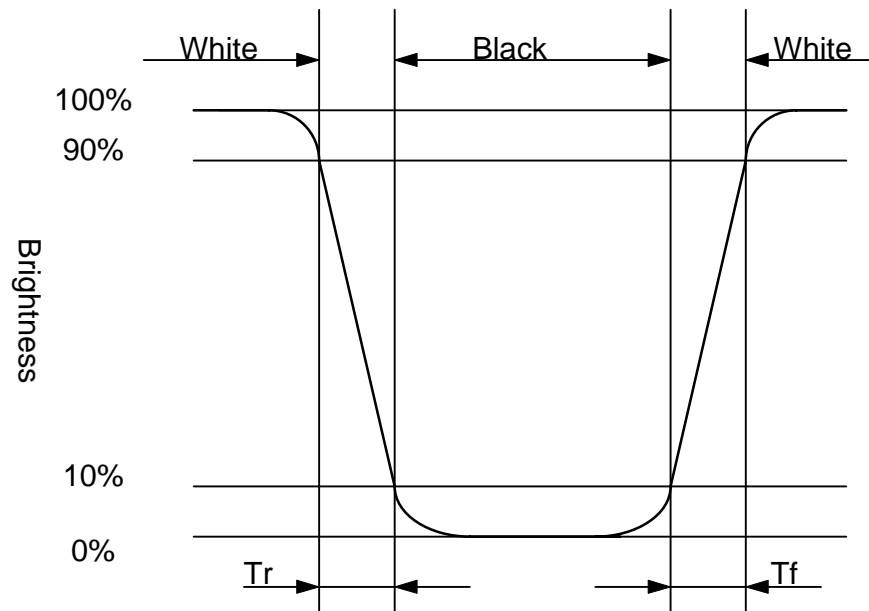



8-2) Testing configuration

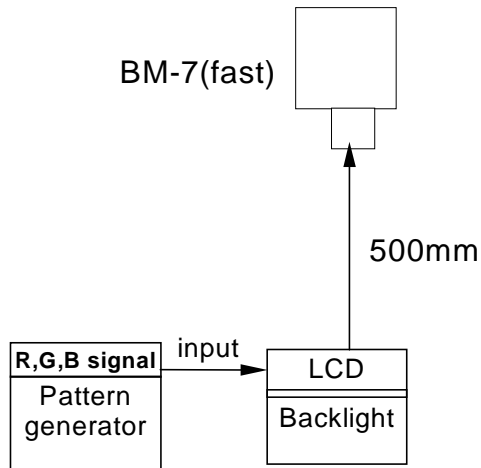

Caution: 1. Environmental illumination 1 lux  
 2. Before test CR, Vcom voltage must be adjusted carefully to get the best CR.

- LCD Display Testing Point

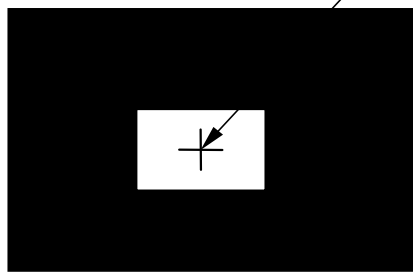

Pattern A

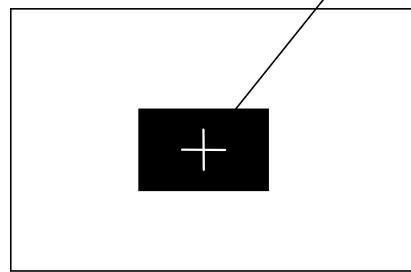

Pattern B

- R, G, B Waveform of Pattern A at Testing Point

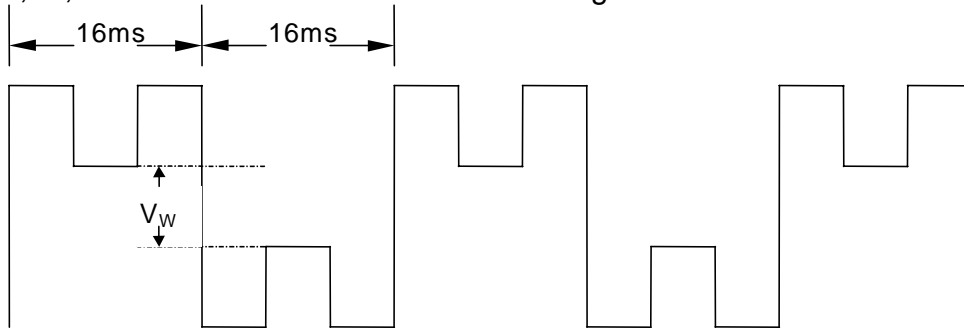

$$V_w = 2.2V \pm 0.2V$$

- G, B Waveform of Pattern B at Testing Point

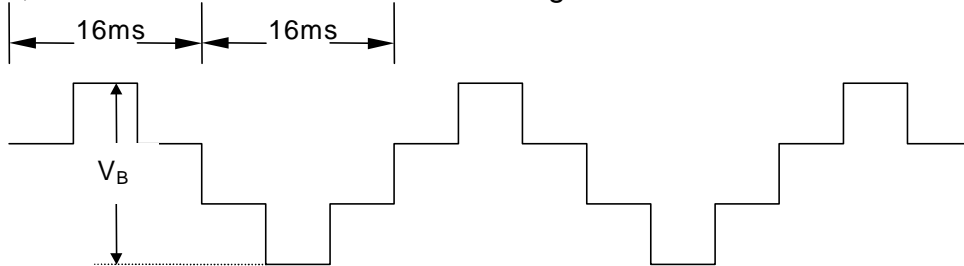

$$V_w = 9.2V \pm 0.2V$$

## 9. Handling Cautions

### 9-1) Mounting of module

- a) Please power off the module when you connect the input/output connector.
- b) Please connect the ground pattern of the inverter circuit surely. If the connection is not perfect, some following problems may happen possibly.
  - 1. The noise from the backlight unit will increase.
  - 2. The output from inverter circuit will be unstable.
  - 3. In some cases a part of module will heat.
- c) Polarizer which is made of soft material and susceptible to flaw must be handled carefully.
- d) Protective film (Laminator) is applied on surface to protect it against scratches and dirt. It is recommended to peel off the laminator before use and taking care of static electricity.

### 9-2) Precautions in mounting

- a) When metal part of the TFT-LCD module (shielding lid and rear case) is soiled, wipe it with soft dry cloth.
- b) Wipe off water drops or finger grease immediately. Long contact with water may cause discoloration or spots.
- c) TFT-LCD module uses glass which breaks or cracks easily if dropped or bumped on hard surface. Please handle with care.
- d) Since CMOS LSI is used in the module. So take care of static electricity and earth yourself when handling.

### 9-3) Adjusting module

- a) Adjusting volumes on the rear face of the module have been set optimally before shipment.
- b) Therefore, do not change any adjusted values. If adjusted values are changed, the specifications described may not be satisfied.

### 9-4) Others

- a) Do not expose the module to direct sunlight or intensive ultraviolet rays for many hours.
- b) Store the module at a room temperature place.
- c) The voltage of beginning electric discharge may over the normal voltage because of leakage current from approach conductor by to draw lump read lead line around.
- d) If LCD panel breaks, it is possibly that the liquid crystal escapes from the panel. Avoid putting it into eyes or mouth. When liquid crystal sticks on hands, clothes or feet. Wash it out immediately with soap.
- e) Observe all other precautionary requirements in handling general electronic components.
- f) Please adjust the voltage of common electrode as material of attachment by 1 module.

## 10. Reliability Test

No	Test Item	Test Condition
1	High Temperature Storage Test	Ta = +80 C, 240 hrs
2	Low Temperature Storage Test	Ta = -30C, 240 hrs
3	High Temperature Operation Test	Ta = +60 C, 240 hrs
4	Low Temperature Operation Test	Ta = -10 C, 240 hrs
5	High Temperature & High Humidity Operation Test	Ta = +60C, 95%RH, 240 hrs
6	Thermal Cycling Test (non-operating)	-25C +25C +70C, 200 Cycles 30 min 5min 30 min
7	Vibration Test (non-operating)	Frequency : 10 ~ 55 Hz Amplitude : 1.5 mm Sweep time : 11 mins Test period : 2 hrs for each direction of X, Y, Z
8	Shock Test (non-operating)	100G, 6ms Direction : ± X, ± Y, ± Z Cycle : 3 times
9	Electrostatic Discharge Test	150pF, 330 Air : ± 15KV; Contact : ± 8KV 10 times/point, 9 points/panel face

Ta: ambient temperature

### [Criteria]

Under the display quality test conditions with normal operation state, there should be no change which may affect practical display function.

## 11. Indication of Lot Number Label

a) Indicated contents of the label

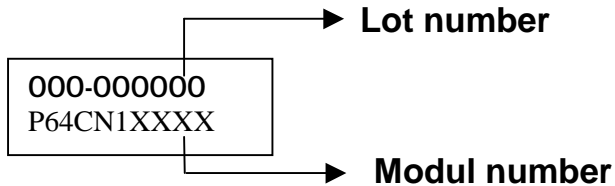

Contents of lot number : 1st—Process area : class 1000 ⇒ H  
class 100K ⇒ M

2nd~3rd—Module screen size(in inch) : 1.8"⇒18, 2.5"⇒25.....

5th—Production year : 1999⇒9, 2000⇒A, 2001⇒1.....

6th—Production month : 1, 2, 3,...9, A, B, C

7th~10th—Serial numbers : 0001~9999

12. Block Diagram

